

# Rollair

## Rotary Screw Compressors

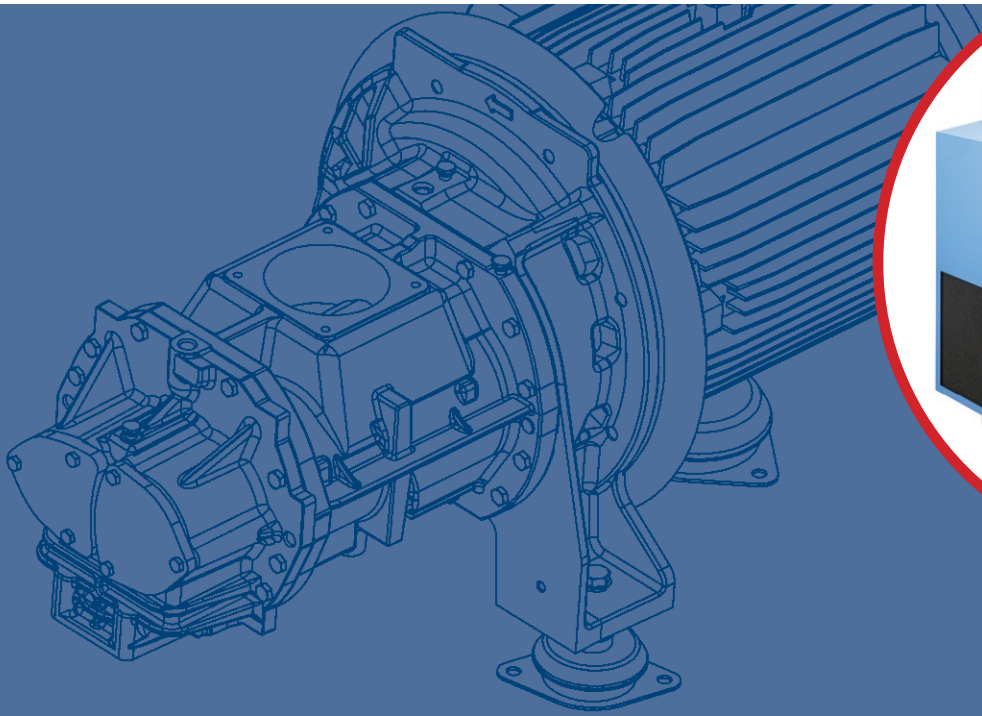

ROLLAIR 30-35-40E-50E (V)

## Worthington Creyssensac's heritage

Creysensac was founded in Nanterre (near Paris), France in 1934 by Elie Creysensac and quickly became renowned in the automotive industry for developing high quality piston compressors.

In the mid nineteen sixties, screw compressors were added to the product portfolio while 1973 saw the merge with Worthington. This further expanded the influence of the company in the compressed air world and reinforced the distributor network.

Today, its long-standing experience and continuous innovation ensure Worthington Creysensac is a trusted partner for its customers.



## Driven by technology Designed by experience

Discover what happens when a passion for technology is fused with hands-on industrial experience. Designs evolve towards more practical installation and maintenance, giving you the freedom to focus on your job. Product ranges include the exact machine you need, with the right options for your performance needs. Return on investment is ensured, while your carbon footprint shrinks. And, because we stay close to our customers, we're one step ahead when your needs change.

**INNOVATION  
HANDS-ON  
EXPERIENCE  
PEACE OF MIND  
TOTAL COST  
OF OWNERSHIP  
PARTNERSHIP**

## The range that meets all your requirements

*With the Rollair range you obtain an efficient, reliable and complete solution which fits a wide range of compressed air requirements.*

### A wide offer for you

- Available power sizes: from 30 up to 50 hp (30 & 35 hp power sizes added).
- 4 pressure variants for fixed speed.
- 4 Rollair V variants, 30-35-40-50 hp direct driven for improved efficiency.
- One pressure variant (5,5-12,5 bar) for Rollair 30-35-40E-50E V.

### High efficiency transmissions

- Reduced energy consumption compared to belt driven technology.
- Low noise levels: the Rollair can be installed close to the workplace.
- Longer service intervals compared to belt technology.

### Easy accessibility and installation

- Easy to service thanks to the large hinged doors and removable panels.
- Easy to install thanks to a high variety of configurations and scope of supply.

### The options you need

- Graphic and integrated central controller.
- Energy recovery.
- Compressed air filter to improve the air quality.
- WSD to protect your dryer from moisture.
- ...and much more to customize your machine!



[www.airwco.com](http://www.airwco.com)

# The right fit for each customer

Check out these innovative features of the Rollair 30-50 range and see how they provide you with a complete offer: high efficiency, easy maintenance and a low noise level.

## High quality drive train (gear and direct transmission)

- Gearbox technology for great energy efficiency and reliability installed on the Rollair 30-35-40E-50E units.
- No long-term loss thanks to the combination of screw rotors and gearbox technology.
- Direct driven transmission (1) for outstanding energy efficiency and reliability installed on the Rollair 30-35-40E-50E V.
- In-house designed element with high performance (specific energy requirements and FAD) C80 gear and DD for 30-35-40E-50E (2).
- Standard IP 55 class F IE3 motor for Rollair 30-35-40E-50E (3).
- IP 54 designed for converter duty motors for 30-35-40E-50E V (4).
- Primary suppliers for main outsourced components like motors and converters (5), with world wide support.

## Highly efficient air intake filtration and oil separation

- Fresh air taken from the cold side of the compressor to improve efficiency.
- Two micron encapsulated intake filters guarantee only clean air enters the compressor (6).
- Spin on oil separation (7) for 30 & 35 hp and internal oil separator with oversized oil vessel (8) for 40 and 50 hp for a pressure drop < 250 mbar.



## Optimal ventilation and oversized cooler

- Improved cooling flow results in a lower working temperature.
- A separated air flow offers you an efficient motor and inverter cooling together with a long life time of oil, components and compressor (9).
- Optimal ventilation flow is assured with low energy consumption.
- Oversized oil and air cooler for better cooling and lower operating temperature (10).



## Integrated inverter

- Easy accessible integrated inverter drive (5).
- Optimal FAD range control.
- New cubicle cooling system to improve electrical device reliability.

## Quiet operation

Thanks to the improved noise insulation, the compressor works very quietly and can be placed near the workplace.

## Air quality

- Internal water separator (11) with automatic drain removes up to 90% of compressed air moisture (standard with dryers).
- Oversized dryer (12) installed in the cold part of the unit to ensure the maximum of moisture removal.

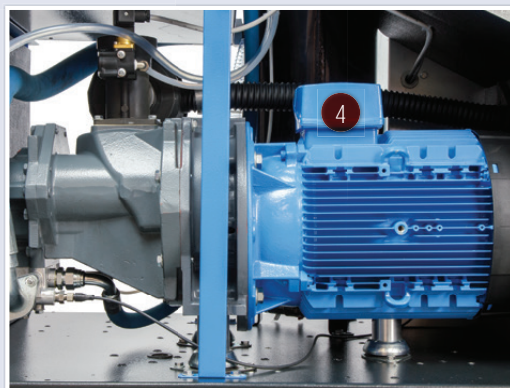

# How to optimize your energy consumption

Energy costs represent about **70%** of the total operating cost of your compressor over a 5-year period. That is why reducing the operating cost of a compressed air solution is a major focus.

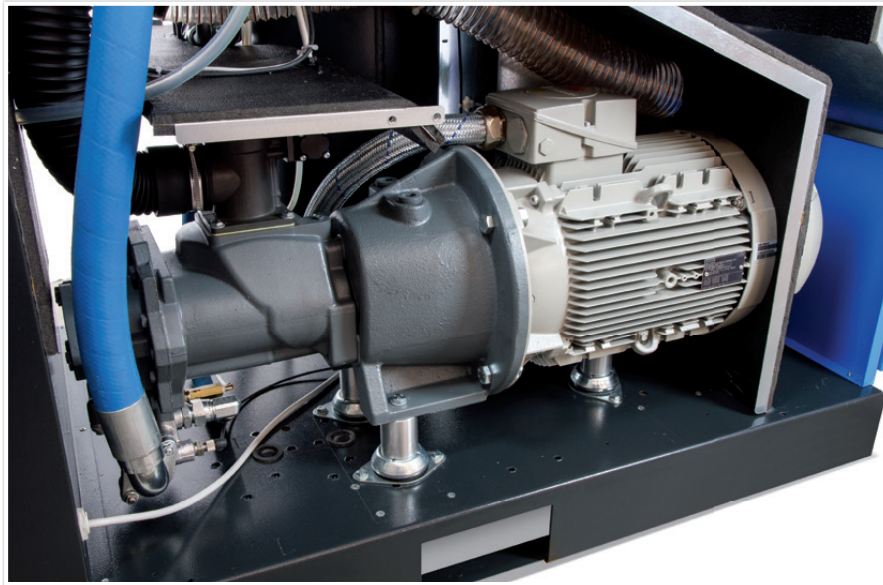

## Variable speed technology

For the right application, variable speed technology, can cut the energy bill of your compressor by up to **30%**.

- The variable frequency drive compressor matches air supply with demand therefore reducing energy consumption when the demand is lower. If the demand is stable then the controller guarantees a fixed set pressure.
- No unload cycles above 20% load.
- No peak current due to soft start.
- Improved efficiency thanks to the new direct driven transmission

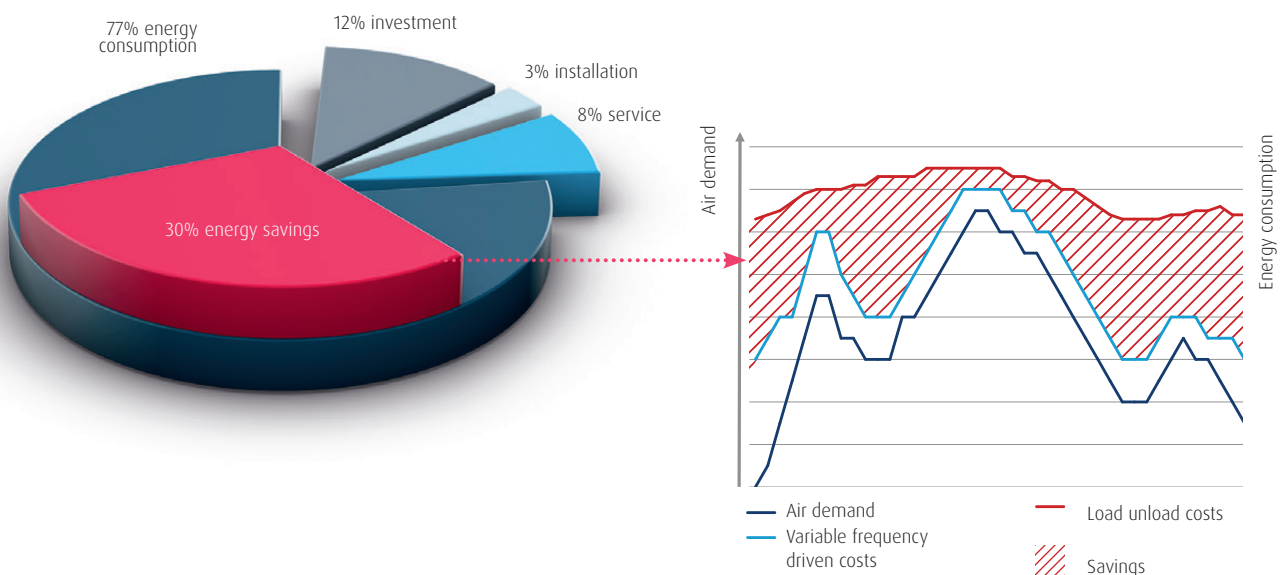

## Always in control with Infologic<sup>2</sup> and Airlogic<sup>2</sup>



### Infologic<sup>2</sup> (standard on Rollair)

- Icon based display action
- Led status visualization.
- Digital I/O.
- Remote start stop, load-unload, emergency stop.
- Automatic restart after a power failure.
- Service indicator and fault management provide comprehensive messages to ease service diagnostics.
- Visualization through web browser using a simple Ethernet connection.



### Airlogic<sup>2</sup> (standard on Rollair V optional on Rollair)

The Airlogic<sup>2</sup> takes your control to the next level, offering additional functionalities:

- User-friendly graphic screens, data logging and storage on a memory card.
- Stop/start timers do not rely on the operator's action to save energy, but program the Airlogic<sup>2</sup> controller to operate as your factory operates.
- Dual pressure band time scheduling for operation with different pressure bands, leading to energy savings.

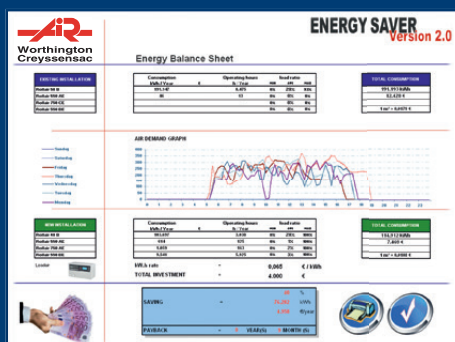

### Energy audit

Knowing what compressor is right for your application is critical to minimizing the energy consumption. With our Energy Audit we can simulate your compressed air needs and then consult you on the best solution for your needs.

For more information, please contact your local Worthington Creyssensac representative.

## Improve your energy recovery

When air is compressed, heat is formed. The excess heat can be captured with an energy recovery option and channeled to other applications allowing you to save energy and cut costs.

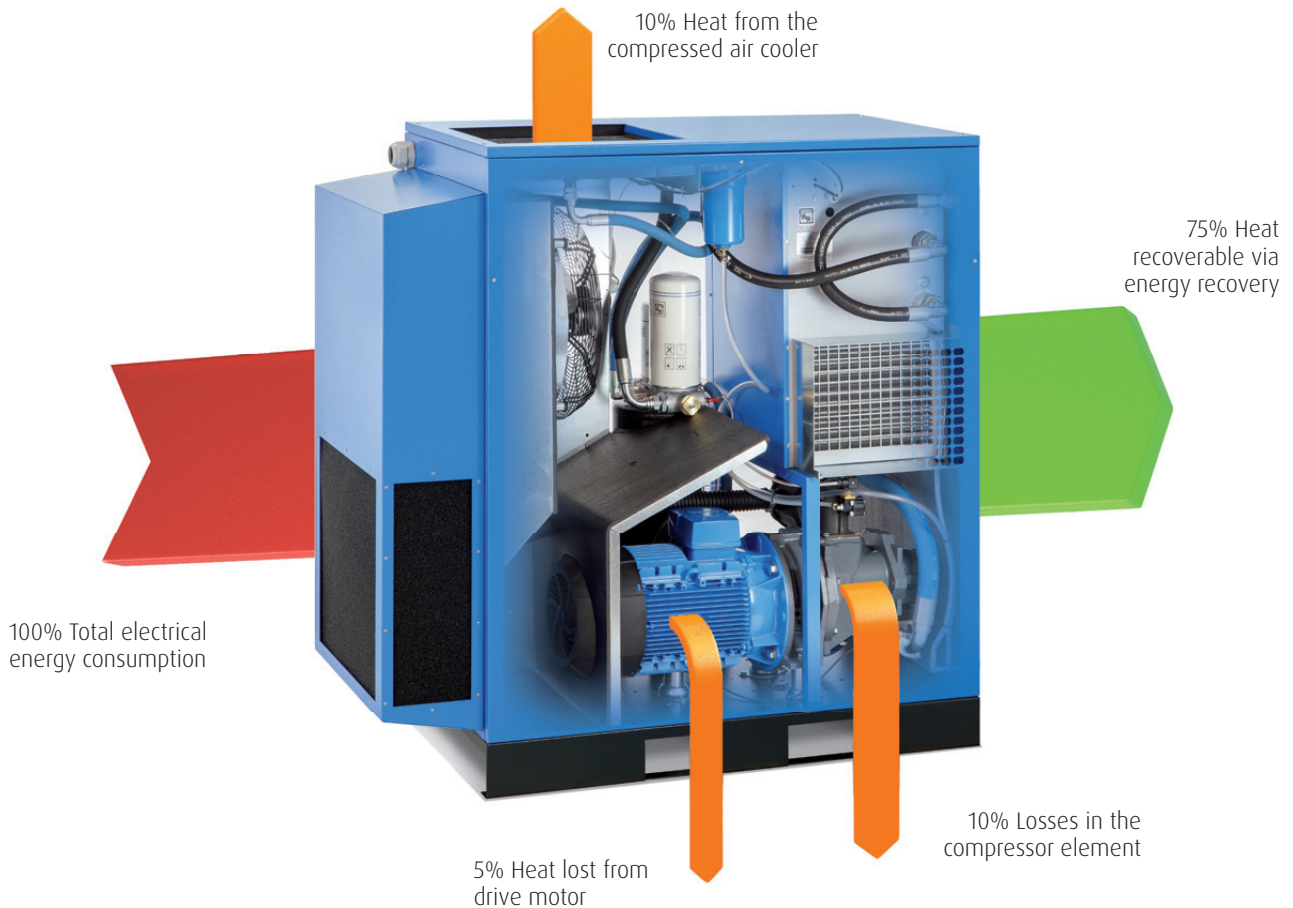

### Water cooling recovery

In the energy recovery units (optional) the oil circuit is pre-cooled with an oil/water heat exchanger. Water then becomes the fluid transport media to recover the oil temperature. The hot water resulting from this process can be used to heat radiators or water boilers, pre-heat supply water or hot tap water, and other industrial applications.

The energy recovery option integrates a heat exchanger on the oil circuit, which heats up the continuously pressurized water flow. The system is regulated automatically, and in case of limited water cooling capacity, the standard cooling system of the compressor will operate and backup the energy recovery device.

The energy recovery option is a simple mechanical system that requires no maintenance or electricity consumption, but offers you significant reductions in your energy costs.





## Options to optimize your operations

A wide range of options enables you to get the most out of your Rollair 30-35-40E-50E (V).

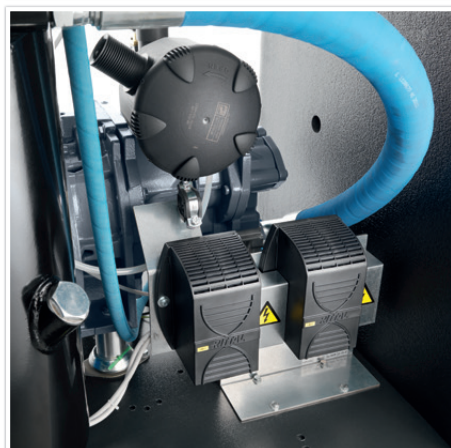

### Air quality

- **Internal water separator with automatic drain** reduces up to 90% of the compressed air moisture. Standard on 30-35-40E-50E (V) T versions.
- **Line filter** for oil and dust removal down to 0.1 ppm for plus versions.
- **Heavy duty air intake filtration** prevents dust entering the pneumatic circuit in very dusty environments (standard on Rollair & Rollair V 40 & 50).
- **Canopy heater** for low temperature installation.
- **Electronic zero loss drain** for water separator to easily drain the condensate without any compressed air loss.
- **Food grade oil** for food & beverage applications

### Efficiency

- **Energy recovery pack** to recover up to 70% of the electrical energy consumption as warm water for showers, boilers etc.
- **8000h oil**

### Safety

- **Electrical main switch**

### Control & monitoring

- **Airlogic<sup>2</sup> Graphic Control** (standard on Rollair V - Optional on Rollair)
- **EControl6i** integrated multiple compressor control for 4/6 compressors (with Airlogic<sup>2</sup> only).
- **Remote monitoring** for additional convenience.

For further information on how our options can optimize your operations, please contact your local representative.

# Technical specifications

Fixed Speed

Model	Version	Max. working pressure bar	Free Air Delivery @ reference conditions**			Motor power		Noise level *** dB(A)	Cooling air volume m <sup>3</sup> /h	Weight	
			m <sup>3</sup> /h	l/s	cfm	kW	hp			FM	FM T
<b>Rollair 30*</b>	A	7,5	237	66	140	22	30	66	2300	465	540
	8 bar	8,5	223	62	131						
	B	10	203	56	119						
	C	13	175	49	103						
<b>Rollair 35</b>	A	7,5	277	77	163	26	35	67	4800	480	555
	8 bar	8,5	263	73	155						
	B	10	241	67	142						
	C	13	209	58	123						
<b>Rollair 40E</b>	A	7,5	335	93	197	30	40	68	4800	580	701
	8 bar	8,5	306	85	180						
	B	10	281	78	166						
	C	13	245	68	144						
<b>Rollair 50E</b>	A	7,5	374	104	220	37	50	69	4800	643	764
	8 bar	8,5	346	96	204						
	B	10	310	86	183						
	C	13	281	78	166						

\* Available only for 400 V 50Hz - IEC - CE

\*\* Unit performance measured according to ISO 1217, Annex C, latest edition.

\*\*\* Noise level measured according to ISO 2151 2004.



## Technical specifications

Variable Speed

Model	Min. working pressure bar	Max. working pressure bar	Free Air Delivery @ reference conditions**										Motor power		Noise level dB(A) ***	Cooling air volume m <sup>3</sup> /h	Weight	
			Min. FAD**				Max. FAD**						kW	hp			FM	FM T
			m <sup>3</sup> /h	l/s	m <sup>3</sup> /h	cfm	m <sup>3</sup> /h	cfm	m <sup>3</sup> /h	cfm	m <sup>3</sup> /h	cfm						
<b>Rollair 30 V*</b>	5	13	47	13	255	151	248	146	215	126	180	106	22	30	66	2300	456	525
<b>Rollair 35 V</b>	5	13	47	13	290	168	284	167	252	148	209	123	26	35	67	4800	466	535
<b>Rollair 40E V</b>	5	13	61	17	348	202	334	197	295	174	248	146	30	40	68	4800	515	630
<b>Rollair 50E V</b>	5	13	65	18	380	221	374	220	331	195	270	159	37	50	69	4800	537	652

\* Available only for 400 V 50Hz - IEC - CE

\*\* Unit performance measured according to ISO 1217, Annex C, latest edition.

\*\*\* Noise level measured according to ISO 2151 2004.

## Dimensions Fixed Speed & Variable Speed

Rollair & Rollair V	Length	Width	Height
	mm	mm	mm
<b>30-35-40E-50E standard</b>	1555	830	1555
<b>30-35 with dryer (T)</b>	1555	830	1555
<b>40E-50E with dryer (T)</b>	2030	830	1555





**Worthington  
Creysensac**

**DRIVEN BY TECHNOLOGY DESIGNED BY EXPERIENCE**



**CONTACT YOUR LOCAL  
WORTHINGTON CREYSENSAC  
REPRESENTATIVE**

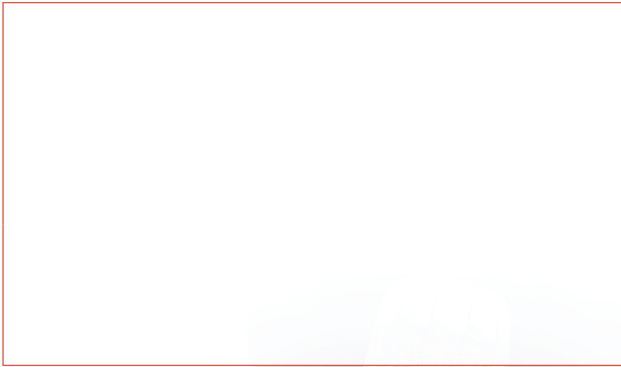

Care. Trust. Efficiency.

**Care.**

Care is what service is all about: professional service by knowledgeable people, using high-quality original parts.

**Trust.**

Trust is earned by delivering on our promises of reliable, uninterrupted performance and long equipment lifetime.

**Efficiency.**

Equipment efficiency is ensured by regular maintenance. Efficiency of the service organization is how Original Parts and Service make the difference.



[www.airwco.com](http://www.airwco.com)